

# OPTIMUS

## VEGA

Optimus Vega – Remote gas canister stove for outdoor use

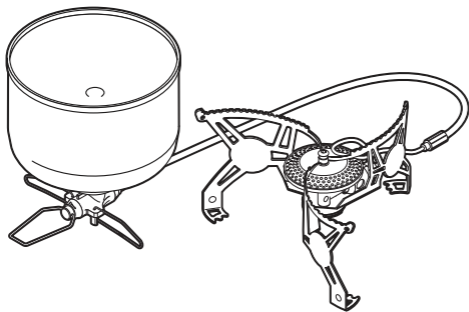

EN

FR

DE

NL

DK

SWE

NO

FI

IT

ES

PT

PL

CZ

RU



UK  
CA

CE 0085



OPTIMUS | CLEVER COOKING SINCE 1899™

FIGURE [1]

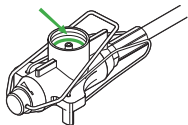

FIGURE [2]

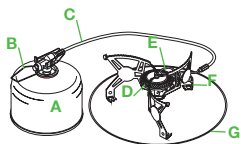

FIGURE [6]

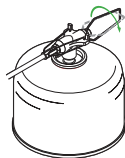

FIGURE [3]

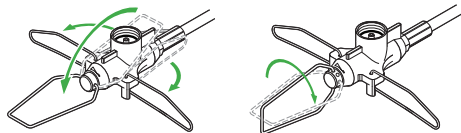

FIGURE [4]

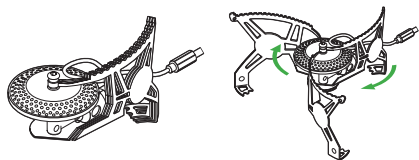

FIGURE [5A]

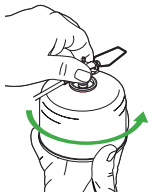

FIGURE [5B]

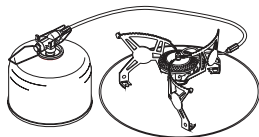
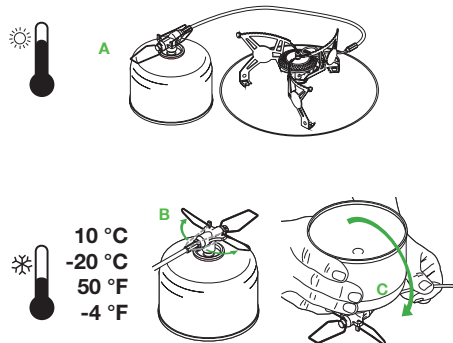

FIGURE [7]



**WARNING:** Improper installation, use, adjustment, alteration, service or maintenance can cause injury or property damage. Refer to this manual. For assistance or additional information consult a qualified retailer, service agency or gas supplier.



## **WARNING**

### **FIRE OR EXPLOSION HAZARD**

**If you smell gas:**

- 1. Do not attempt to light stove.**
- 2. Extinguish any nearby flame(s).**
- 3. Disconnect from fuel supply.**
- 4. Evacuate area immediately.**
- 5. Allow gas to dissipate 5 minutes.**

**Failure to follow these instructions could result in fire or explosion, which could cause property damage, personal injury, or death.**

**⚠ DANGER****CARBON  
MONOXIDE  
HAZARD**

**This appliance can produce carbon monoxide which is poisonous and has no odor.**

**Using it in an enclosed space can kill you.**

**Never use this appliance in an enclosed space such as a camper, tent, car or home.**

**FOR YOUR SAFETY**

**Do not store or use gasoline or other liquids with flammable vapors in the vicinity of this or any other appliance.**

# SAFETY FIRST

---

**IMPORTANT:** Read these instructions for use carefully. Familiarise yourself with the appliance before connecting it to its gas container. Keep these instructions for future reference. **FOR OUTDOOR USE ONLY**



## DANGER

**This stove uses a liquid pressurized gas (LPG) canister that is highly flammable and explosive. Improper or unsafe use can result in accidental fire and explosions which can cause serious injury or possible death.**

- Listen and smell for leaking gas. LPG is invisible and may be odorless as its strong odorant can fade over time. As a result, leaks are not always detectable by smell.
- If you suspect that there is a leak, do not use the stove or canister. To locate and stop the leakage, move stove to a well-ventilated area outdoors away from any ignition source. Check that the stove and fuel canister connection is secure and tight.
- Do not leave this appliance unattended while the appliance is in operation. Keep children and pets away from the appliance at all times.



## WARNING

**Risk of fire and explosion when using fire to detect gas leaks.**

- Do not try to detect leaks using a flame, use soapy water.
- Check that seals (between the stove and the gas cartridge) are in place and in good working condition before connecting to the gas cartridge. Do not use the stove if it has damaged or worn seals. **FIGURE [1]**

**If you expose the fuel canister to high heat, the canister could explode or leak.**

- Keep stove and fuel canister away from other heat sources.
- Follow all warnings on fuel canister regarding use and storage.
- Do not attach or remove canister near high heat, open flames, direct sunlight, other ignition sources or where temperature of canister exceeds 50°C (120°F).
- Do not store or use gasoline or any other liquids with flammable vapors in the proximity of this stove.
- Only use fuel canisters which are intended to be used with this stove.

## INSTRUCTION FOR USE

---

Only use the stove as described in this manual.

### FIGURE [2]

|                                |                            |
|--------------------------------|----------------------------|
| <b>A:</b> Gas canister         | <b>E:</b> Pre heating tube |
| <b>B:</b> Remote Control Valve | <b>F:</b> Pot support legs |
| <b>C:</b> Fuel Hose            | <b>G:</b> Ground shield    |
| <b>D:</b> Burner               |                            |

### TECHNICAL SPECIFICATIONS

**Gas Category:** direct pressure I3B/P– butane/isobutane/propane mix. **Combustibles:** Use only Optimus 100,110,220,230,450g gas cartridges certified to the EN417 standard. IT MAY BE HAZARDOUS TO ATTEMPT TO FIT OTHER TYPES OF GAS CANISTERS. **Weight:** 178 g  
**Dimension folded:** 130 x 70 x 65mm **Rating:** 2.6kW nominal EN521; 1.4kW vapour gas mode EN417, 3.7kW liquid gas (4 season mode) and 185g/h, ANSI Z21.72-2019/CSA 11.2-2019: 6'000BTU/h vapour gas. **Injector size of stove:** 0.32mm **Burn time:** Up to 160min at maximum output (230g canister) in vaporized gas mode **Boil time:** 4.5min for 1 liter in efficiency mode depending on climate etc.

## 1 SET UP STOVE

---

1. Lay out fuel hose to full length and make sure that it is not twisted in any place.
2. Fold out the control valve handle and make sure that it is fully closed (turned fully clockwise). **FIGURE [3]**
3. Check that O-ring connects to gas canister before each use for damage (see under 5. Maintenance). **FIGURE [1]**
4. Fold out legs of the stove. Legs lock into place automatically by turning them clockwise until resistance is felt. **FIGURE [4]**

## 2 CONNECT STOVE TO GAS CANISTER

---

1. Hold onto the canister fuel adaptor of the valve housing and screw the canister counterclockwise tightly. Tighten by hand only and be careful not to damage the threads when you connect the gas canister.
2. Always keep the gas canister in upright position while connecting to the stove. **FIGURE [5A]**
3. Always ensure that the stove is placed on a firm horizontal surface before using it.
4. Allow plenty of free space around the stove, at least 1.25m (4ft) on each side and 1.5m (4.5ft) above it.
5. It gets very hot under the stove, so remember to place it on a firm base which is not flammable. It is compulsory to use a ground shield when using this appliance on a combustible surface. **FIGURE [5B]**
6. When a canister change is necessary, please follow steps 1-4 of this manual carefully. Change the gas canister outside and away from people.

### **WARNING**

**Risk of burning or serious injuries due to gas leakage hazard.**

- This appliance should only be used on a horizontal surface in an open air situation with natural ventilation without stagnant areas, where gas leakages and products of combustions are rapidly dispersed by wind and natural

convection.

- Never light the stove if you detect a hissing sound or the smell of gas after tightening the canister. The gas has an additive with a foul smell. Never use a stove that smells of gas.
- Do not use the stove if it has damages or worn seals. Do not use the stove if it is leaking, damaged or if it does not operate properly.
- Never over-tighten gas canister when connected to the stove. Overtightening can damage stove or canister causing gas to leak.
- Use extreme caution when using stove in temperatures below freezing. In freezing temperatures, O-rings can stiffen and leak gas.
- Always check for gas leaks before and after lighting the stove.
- Keep children more than 3m (10ft) away from stove and fuel.
- Keep highly flammable fabrics away from stove, such as outdoor clothing, sleeping bags, tents etc.

### 3 USE THE STOVE TO COOK

---

1. Always light up your stove with the canister in upright position (vaporized gas mode) to avoid large flare ups.  
**FIGURE [6]**
2. Open the control valve approximately one turn counter-clockwise and light the burner. The flame ring should be complete and the flame should be mostly blue and non-pulsating in normal operation.  
**CAUTION:** If flame turns yellow and grows higher when operating the stove in liquid gas mode, simply adjust flamesize by turning the control valve clockwise.
3. Adjust the control valve to get the flame you want.
4. If the output is weak, it could mean the gas is running out, or that the canister is too cold. Turn off the stove and let it cool down. Make sure there is no open flame nearby when changing the gas canister.
5. As this is a remote burner stove, there will always be a delay between turning the control spindle and the effect on



the flame. Especially when the stove is used in liquid gas mode, this delay will be longer (up to 30s).

6. **CAUTION:** accessible parts may become very hot. Keep young children and pets away from the stove.

### **TIPS FOR OPTIMAL USAGE: FIGURE [7]**

**Vapor gas mode:** For normal conditions and simmering - most fuel efficient mode.

**Liquid gas mode:** For cold conditions and low gas pressure in canister only. - high gas consumption.

In cold weather, the butane/isobutane/propane mix is adversely affected by the cold. The gas mix becomes less efficient even at 0°C (32°F). The butane ceases to vaporize and the stove runs solely on isobutane and propane. If the propane runs out, you can only use the rest of the container at temperatures above freezing.

- Use the stove in vapor gas mode in normal conditions and for optimal simmering results. **FIGURE [7A]**
- Use the stove in liquid gas mode when cooking in colder conditions. Fold out the canister support legs on the valve and turn canister over slowly. **FIGURE [7B]** Keep the canister low when inverting it and hold fuel hose with one hand in position to avoid movement of the stove. **FIGURE [7C]** Take extra care that canister is standing stable and continue cooking in liquid gas mode.
- Keep the gas canister warm inside your jacket or in your sleeping bag at night.

## **WARNING**

**Risk of burning or serious injuries due to flare up hazard when lighting up the stove in liquid gas mode**

- Never light up your stove in liquid gas mode as this can lead to flare ups.
- Let the stove burn for 30s before inverting the canister for preheating.
- Never hold your face or any other part of your body over the stove while lighting or cooking.

- Never shake a canister when the stove is lit as you risk big flames shooting up.
- **If flame turns yellow and grows higher when operating the stove in liquid gas mode, simply adjust the flamesize by turning the control valve clockwise.**

## **WARNING**

### **Overheating and explosion hazards**

- Never allow the canister to be inside a windscreen perimeter.
- Keep solid combustibles at least 1.25m (4ft) away from the top and 1m (3ft) from sides of a burning stove or a stove that you are in the process of lighting.
- Keep flammable liquids and vapors at least 8m (25ft) away from the top and sides of a burning stove, or a stove that you are in the process of lighting.
- Never attempt to light a stove if control valve has been left open. If control valve is left open, close it immediately and thoroughly ventilate area before lighting stove. Failure to ventilate area can result in an explosion.
- Never use cookware with a diameter larger than 220mm (8.5in). The pan plus food must not weigh more than 4kg (8.8lbs) combined.
- Never place and operate 2 or more stoves together.
- Never operate stove with empty or dry cookware.

## **4 TURN OFF, COOL AND PACK STOVE**

---

1. Turn off the stove and double-check that the flame is completely extinguished.
2. Allow stove to cool properly.
3. Disconnect the gas canister after having double checked that the flame is completely extinguished and that gas supply is fully turned off by turning the control valve handle fully clockwise.
4. It is normal for a small amount of gas to fizz out when you unscrew the gas canister.
5. Fold in pot support legs, wrap fuel hose around the stove and store in stuff sack.

6. How to check if the gas container is empty: Gently shake the gas container - if movement of liquid is sensed or audible then gas is present in the container.

## **WARNING**

### **Risk of burning due to fire hazard**

As the Vega is a remote canister stove, there is a delay between closing the valve and extinguishing the flame. This delay can take up to 30s when stove is turned off in liquid gas mode.

## **CAUTION**

### **Burning hazard due to incorrect handling and storage**

Storing fuel canisters near any heat or ignition source, or where temperatures exceed 50°C (120°F) can result in the canister exploding.

- Never move a burning or hot stove. Allow stove to cool for at least 10min before moving it.
- Never transport or store the stove with the gas canister connected.
- Always store gas canisters in a well-ventilated area away from any possible heat or ignition source such as: water heaters, stoves, pilot lights, furnaces or where temperatures exceed 50°C (120°F).

## **5** **MAINTENANCE**

---

Before each use, check the O-ring where the stove connects to the gas canister. **FIGURE [1]** Leakage may result if the O-ring is not in place, or if it is worn or damaged. Replace the O-ring by tweezing it out with a tool such as the blunt end of a sewing needle. Never use a sharp or pointed object that can damage the seal surfaces. Fit the new O-ring with care to avoid damaging it. Only use original Optimus O-rings (Art. No. 8017867) for this purpose. Do not modify the stove. Only qualified individuals are allowed to do additional service. For major repairs send the stove back to Optimus. This appliance is not designed to be serviced by the user, and

contains no user serviceable parts.

## LIMITED WARRANTY

Optimus provides a 2 year limited warranty against manufacturing defects for the original stove purchaser. Proof of purchase is required for this warranty to be valid. This warranty does not cover damage due to accident, improper use or modifications.

If you have any problems with your Optimus Vega, return it to your dealer or contact Katadyn. Clean food and dirt from the stove before returning it. For more information, contact your dealer or Katadyn Products Inc. in Switzerland at +41 44 839 21 11 or e-mail us at [customerservice@katadyn.ch](mailto:customerservice@katadyn.ch). US customers please contact Katadyn North America at 1-800-755-6701 or [cs@katadyn.com](mailto:cs@katadyn.com).

This warranty gives you specific legal rights and you may have other legal rights which vary from state to state.

Please visit our website for additional information about our other products. **[www.optimusstoves.com](http://www.optimusstoves.com)**

**For clean water and freeze dried food, visit [www.katadyngroup.com](http://www.katadyngroup.com)**

**Manufacturer:**

Katadyn Products Inc.  
Pfäffikerstrasse 37  
8310 Kempthal | Switzerland  
+41 44 839 21 11  
customerservice@katadyn.ch  
www.optimusstoves.com

**Distributor USA/Canada:**

Katadyn North America Inc  
130 Cyber Court  
Rocklin, CA 95765 | U.S.A  
+1 800 755 6701

**Distributor Europe:**

Katadyn Deutschland GmbH  
Hessenring 23  
64546 Mörfelden-Walldorf | Germany  
+49 61 05 45 67 89

Certified to:

CSA/ANSI Z21.72 • CSA 11.2 2019  
Camp Stove / Poêle de camping  
EN 521

OPTIMUS VEGA  
ARTICLE NO. 8018505  
PRINT NO. 8017537/6